

# Brooks® Models MT 3809 and 3819 Metal Tube Variable Area Flowmeters with Optional Transmitters and Alarms

- Broad range of flow capacities
- 2% Full scale accuracy
- Versatile construction for all gas, liquid, steam applications
- Operable under high temperatures and pressures
- Flanged or female NPT connections
- Optional 4-20mA and HART® programmable microprocessor transmitter with or without alarms and pulse output for totalization
- Electronics designed with either intrinsically safe or explosion proof construction to meet UL (US & Canada) ATEX certifications and CE requirements

## DESCRIPTION

The Brooks® Models MT 3809 and MT 3819 Variable Area Flowmeters are rugged, all metal flowmeters offering 2% full scale accuracy. The Model MT 3809 is constructed with stainless steel components for measuring a variety of gas, liquid and steam applications while the Model MT 3819 utilizes a ETFE (Tefzel™) lining for aggressive liquid and gas applications.

Flow rate indication is provided by means of magnetic coupling where a magnet, encapsulated in the float, is coupled to a rotatable magnet located in the rear of the indicator, thus turning the dial indicator mounted on the meter.

Optional accessories available include 4-20 mA output with HART microprocessor transmitter with or without configurable alarms and pulse output for totalization.

Also available are front adjustable inductive alarms, high temperature or stainless steel indicator housings, valves, flow controllers and material certifications.



## SPECIFICATIONS - METER

### Capacities, Pressure Drop and Viscosity Immunity Ceiling

Refer to Tables 1A and 1B

### Accuracy

Standard Flow Accuracy:  $\pm 2\%$  Full Scale

Optional Flow Accuracy:  $\pm 1\%$  Full Scale

### Repeatability

0.25% Full Scale

### Pressure Ratings

Refer to Table 2 for Model MT 3809 maximum non-shock pressure. Model MT 3819 pressure rating is dependant on flange rating.

### Pressure Equipment Directive (PED) 97/23/EC

Flow meter complies under Sound Engineering Practices (SEP) or Categories I, II or III

## Models MT 3809 & 3819

---

### **Scales**

Standard: Detachable aluminum plate (Single or dual scales)

Graduations: Choice of direct reading units, millimeters or percentage of maximum flow

### **Operating Fluid Temperature Limits (Meter only)**

Minimum MT 3809 and MT 3819: -20°F (-29°C)

Maximum:

Standard MT 3809: 420°F(215°C)

Standard MT 3809 with Valve: 392°F(200°C)

Refer to Table 3 for temperature limitations for meters with electronics.

### **Materials of Construction:**

#### **Metering Tube**

MT 3809 Standard: 316L stainless steel

MT 3809 Optional: Inconel 625™, Hastelloy C™, titanium

MT 3819 Standard: 316L stainless steel with ETFE (Tefzel) lining

#### **Flanges and End Fittings**

MT 3809 Standard: 316/316L stainless steel dual certified

MT 3809 Optional: Inconel 625, Hastelloy C, titanium

MT 3819 Standard: 316L stainless steel

#### **Connections**

MT 3809 Standard:

150 lbs, 300 lbs or 600 lbs RF ANSI B 16.5 flanges or PN 40 DIN 2527/2635; or JIS flanges 10K or 20K; or Female NPT, Male NPT for No O-ring meter only  
125/250 Ra micro inch (3.2/6.3 Ra micro meter) cerated flange finish. Consult factory for optional uncerated flange finish.

Vertical inlet and outlet

MT 3819 Standard:

150 lbs RF ANSI B 16.5 flanges or PN 40 DIN 2527/2635

MT 3819 Optional:

300 lbs RF ANSI B 16.5 flanges or PN 40 DIN 2527/2635. For other ratings/flange types consult factory.  
125/250 Ra micro inch (3.2/6.3 Ra micro meter) cerated flange finish. Consult factory for optional uncerated flange finish.

Vertical inlet and outlet

### **Floats**

MT 3809 Standard: 316L stainless steel

MT 3809 Optional: Inconel 625, Hastelloy C, titanium

MT 3819 Standard: Hastelloy C, Sizes 7 and 8, PVDF Sizes 10, 12 and 13.

MT 3819 Optional: Inconel 625 or titanium all sizes; all Teflon® internals Sizes 10, 12 and 13.

### **O-rings (NPT only)**

MT 3809 Standard: Viton®fluoroelastomers

MT 3809 Optional: Teflon®, none with male NPT connections

MT 3819: None

### **Indicator Housing and Cover**

Enclosure NEMA 4X construction

MT 3809 and MT 3819 Standard Housing: Die cast aluminum, polyurethane paint with glass window

MT 3809 and MT 3819 Optional Housing: 316L stainless steel with gritblast and glass window; epoxy paint for aluminum housing

### **Meter Dimensions**

Refer to Figure 1

### **Ordering Information and Model Code**

Refer to Table 4

### **OPTIONAL ACCESSORIES**

Needle control valves and flow controllers (available on the MT 3809 only)

For flow rate control, needle control valves or flow controllers may be externally piped into the inlet or outlet side of the instrument. Needle control valves and flow controllers can be supplied up to size 10 (1") maximum 6.6 gpm (1,500 l/hr) water equivalent.

### **OPTIONAL ELECTRONIC EQUIPMENT**

Electronic equipment available with the Models

MT 3809 and MT 3819 include the Microprocessor Transmitter, Microprocessor Transmitter/Alarm/Pulse Output for totalization, Inductive Alarms, and Transmitter with Inductive Alarms, refer to pages 6 through 15 for additional information. All models are designed to be either Intrinsically Safe (aluminum or stainless steel housing) or Explosion Proof (aluminum housing only). All electronic accessories options are available for high temperature applications. Refer to Table 3 to determine the appropriate model for your application.

**Data Sheet**

DS-VA-MT3809-3819-eng

September, 2008

**Models MT 3809 & 3819**

*Table 1 Model MT 3809 Capacities, Pressure Drop and Viscosity Immunity Ceiling*

METER SIZE	CONNECTION SIZE		FLOAT CODE	FLOAT MATERIAL STAINLESS STEEL 316L								PED Category
	DIN	ANSI		WATER		AIR <sup>1,2</sup>		Press Drop	Press Drop	VIC (cSt)	Max. Visc	
	DN mm	inches		l/h	gpm	scfm	nm3/h	mbar	inches WC	(cSt)	(cSt)	
7	15	1/2"	A	25	0.11	0.49	0.78	30	13	1	40	SEP
			B*	65	0.28	1.2	2	30	13	1	20	SEP
			C	130	0.59	2.4	3.7	30	13	1	120	SEP
			D*	200	0.88	3.7	5.8	35	15	1	20	SEP
8	15	1/2"	A	250	1.1	5.2	8.2	45	19	2	250	SEP
			B	400	1.7	7.7	12	55	23	1	180	SEP
			C	650	2.8	11	18	60	25	2	475	SEP
			D	1000	4.4	21	33	130	53	1.5	250	SEP
10	25	1"	A	1200	5.2	19	30	60	25	5	475	CAT I, II or III
			B	1500	6.6	31	49	70	29	1.5	400	CAT I, II or III
			C	2400	10	41	65	85	35	7	475	CAT I, II or III
			D	3500	15	65	100	155	63	4	475	CAT I, II or III
12	40	1 1/2"	A	4000	17	67	100	50	21	50	475	CAT I, II or III
			B	6000	26	94	140	60	25	30	475	CAT I, II or III
			C	8000	35	150	230	150	61	2	475	CAT I, II or III
			D	10000	46	210	330	300	121	2	475	CAT I, II or III
13	50	2"	A	6500	28	100	160	50	21	50	475	CAT I, II or III
			B	9500	41	160	250	60	25	50	475	CAT I, II or III
			C	12000	55	200	310	100	41	2.5	475	CAT I, II or III
			D	20000	88	390	620	300	121	1	475	CAT I, II or III
15	80	3"	A	20000	88	390	620	110	45	8	475	CAT I, II or III
			B	30000	130	550	860	140	57	7	475	CAT I, II or III
			C	40000	170	750	1100	280	113	5	475	CAT I, II or III
16	100	4"	A	49000	210	NA	NA	160	65	15	475	CAT I, II or III
			B	70000	300	NA	NA	210	85	10	475	CAT I, II or III
			C	100000	440	NA	NA	300	121	5	475	CAT I, II or III

1. Air flows in scfm are given at 70°F and 14.7 psia
2. Air flows in nm3/h are given at 0°C and 1.013 bar (a)
3. \*Minimum operating pressure required 7 psig / 0.48 bar

*Table 2 Model MT 3819 Capacities, Pressure Drop and Viscosity Immunity Ceiling*

METER SIZE	CONNECTION SIZE		TUBE FLOAT CODE	STANDARD FLOAT MATERIAL CAPACITIES (See Note 3)						PED Category
	DIN	ANSI		WATER		AIR <sup>1,2,4</sup>		Press Drop	Press Drop	
	DN mm	inches		l/h	gpm	scfm	nm3/h	mbar	inches WC	
7	15	1/2"	GA	110	0.48	2	3.2	25	11	SEP
			GB	170	0.75	3.2	5	50	21	SEP
8	15	1/2"	A	250	1.1	4.6	7.3	30	13	SEP
			B	420	1.8	7.7	12	45	19	SEP
			C	500	2.2	9.2	14	40	17	SEP
			D	850	3.7	15	24	130	53	SEP
10	25	1"	A	1400	6.2	26	41	45	19	CAT I, II or III
			B	2000	8.8	37	58	106	43	CAT I, II or III
			C	2400	10	44	70	90	37	CAT I, II or III
			D	3000	13	55	87	130	53	CAT I, II or III
12	40	1 1/2"	A	3000	13	55	87	50	21	CAT I, II or III
			B	4000	18	74	110	75	31	CAT I, II or III
			C	5000	22	92	140	85	35	CAT I, II or III
			D	6000	26	110	170	120	49	CAT I, II or III
13	50	2"	A	6000	26	110	170	95	39	CAT I, II or III
			B	8000	35	147	230	125	51	CAT I, II or III
			C	12000	53	220	340	200	81	CAT I, II or III
			D	15000	66	270	430	225	91	CAT I, II or III

1. Air flows in scfm are given at 70°F and 14.7 psia
2. Air flows in nm3/h are given at 0°C and 1.013 bar (a)
3. Sizes 7 & 8 floats are Hastelloy C-276 (Density = 8.94 kg/dm<sup>3</sup>), Sizes 10, 12 & 13 are PVDF (Density = 4.22 kg/dm<sup>3</sup>)
4. For gas applications operating pressure must be greater than 29 PSIA / 2 bar (a)

## Models MT 3809 & 3819

Table 2 Model MT 3809 Pressure Ratings\*

Flange Rating**	316/316L Stainless Steel (psig at indicated temperature)						
	-20°F to 100°F	200°F	300°F	400°F	500°F	600°F	617°F
150 lb.	275	240	215	195	170	140	134
300 lb.	720	620	560	515	480	450	448
600 lb.	1440	1240	1120	1030	955	905	899

Threaded NPT	316L Stainless Steel (psig at indicated temperature)						
	-20°F to 100°F	200°F	300°F	400°F	500°F	600°F	617°F
7 & 8	1500	1500	1400	1400	1300	1200	1200
10	1500	1500	1400	1400	1300	1200	1200
12	1500	1500	1400	1400	1300	1200	1200
13	1300	1300	1200	1200	1100	1000	1000

\* Model MT 3819 pressure ratings dependent on flange rating.

\*\*Flanges are dual certified 316L/316 stainless steel.

Table 3 Maximum Fluid Temperatures at 104°F (40°C) Ambient

3809 Size	Indicator Only		Indicator with Alarm <sup>1</sup>		Indicator with Transmitter <sup>1</sup>	
	Standard	High Temperature	Standard	High Temperature	Standard	High Temperature
7 & 8	-58° thru 420° F	617° F	-22° thru 320° F	450° F	-22° thru 195° F	300° F
	-50° thru 215° C	325° C	-30° thru 160° C	230° C	-30° thru 90° C	150° C
10 thru 16	-58° thru 420° F	617° F	-22° thru 320° F	617° F	-22° thru 195° F	400° F
	-50° thru 215° C	325° C	-30° thru 160° C	325° C	-30° thru 90° C	200° C

3819 Size	Indicator Only		Indicator with Alarm <sup>1</sup>		Indicator with Transmitter <sup>1</sup>	
	Standard	High Temperature	Standard	High Temperature	Standard	High Temperature
7 thru 13	-22° thru 300° F	300° F	-22° thru 300° F	300° F	-22° thru 195° F	300° F
	-30° thru 150° C	150° C	-30° thru 150° C	150° C	-30° thru 90° C	150° C

3809 & 3819 Minimum and Maximum Ambient Temperature

Indicator Only <sup>2</sup>	Indicator with Alarm or Transmitter
-58° thru 150° F	-22° thru 150° F
-50° thru 65° C	-30° thru 65° C

1. High Temperature option not available with Explosion Proof Housing
2. Ambient Temperature below -22° F / -30° C requires Low Ambient Temperature Option

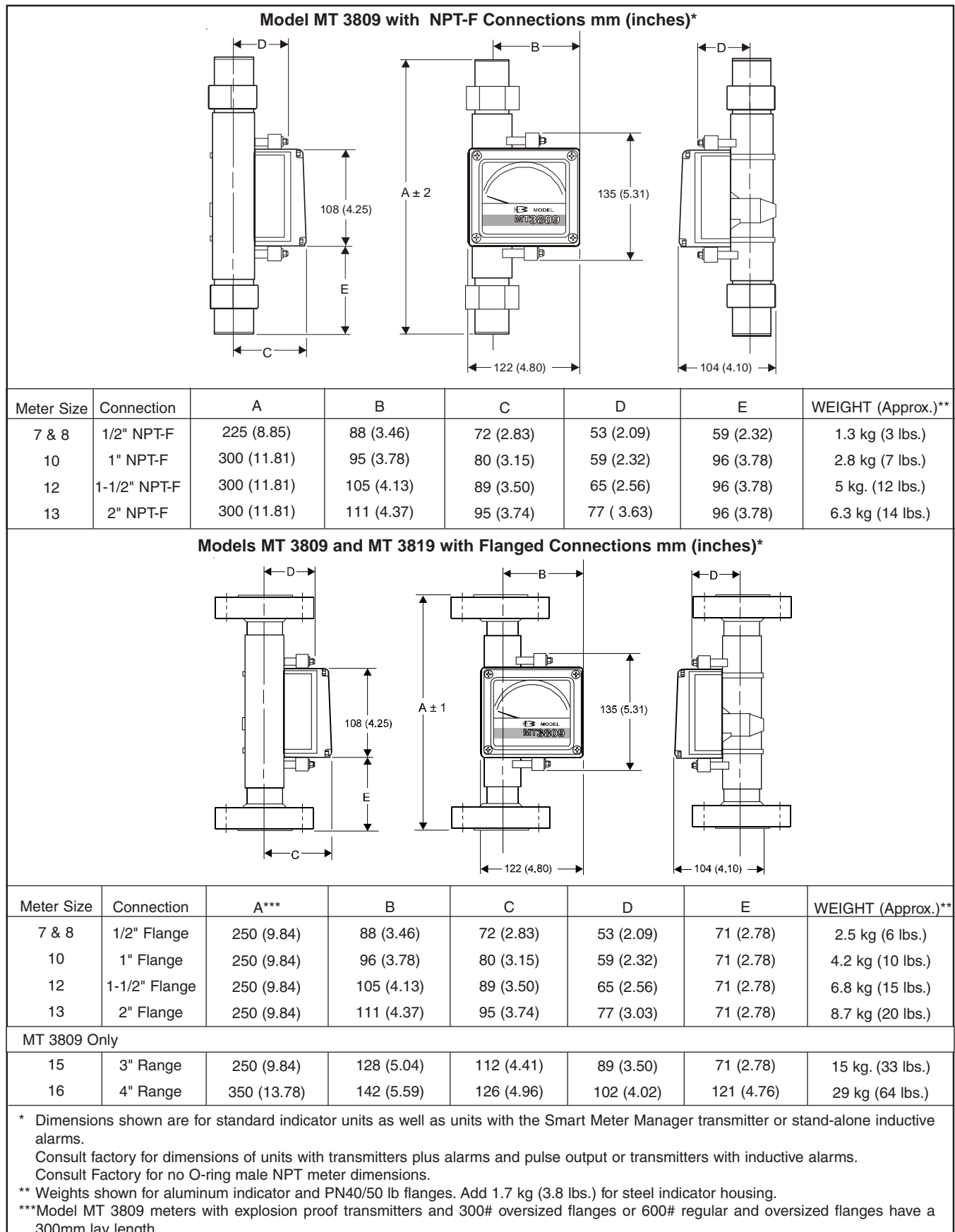

Figure 1 Models MT 3809 and MT 3819 Dimensions

## Models MT 3809 & 3819

---

### Optional Electronic Equipment

#### Microprocessor Transmitter With or Without Alarms and Pulse Output

##### Design Features

- A 2-wire, loop-powered device for ease of wiring and installation
- 4-20 mA analog output for flowrate, with Bell-202 modulated HART communication channel
- User selectable 0% and 100% analog output ranges with optional smoothing
- Flexible (mix & match) units of measure for flowrates, totals, temperatures, densities, etc.
- Two flow totalizers: Resettable and inventory totalization
- User configurable, scaleable pulse output for various engineering units
- Comprehensive alarms for both process flow and internal diagnostic checks
- Easily configured and compatible with other plant equipment
- Patented magnetic sensor which is resistant to external magnetic fields

##### Description

“Smart Inside” best defines the Brooks transmitter with optional alarms and pulse output for totalization. The transmitter (with or without the alarms and pulse output) is a compact microprocessor device designed to interface directly with the Models MT 3809 and MT 3819 flowmeters.

The transmitter is HART-programmable for numerous variables such as flow rate, totalization, calibration factors, and high-low alarm parameters. It is programmable with easy-to-use hand held configurators such as the Emerson™ HART 275 Communicator. Prior to shipment, commonly used default values are programmed by Brooks to ensure ease of operation and quick startup. However, parameters may be reprogrammed by the user if needed. The 2-wire electronics system is easy to install and interface with other existing equipment such as process management systems or maintenance control packages.

In operation the microprocessor transmitter converts the measured process flow into a 4-20mA output with HART protocol. The signal originates when the float magnet inside the metering tube passes a magnetic sensor mounted on the transmitter. Flow rate information may be viewed locally at the meter scale or displayed remotely (along with other flow data) as a function of external support systems through analog/pulse outputs or multiple digital communications.

In addition to transmitter features, this unit can also be ordered with optional alarms and pulse output provided by open collector switches. One or two alarms may be programmed prior to shipment of the unit or at the customer site with a hand-held communicator.

#### Specifications - SMM Microprocessor Transmitter with or without Alarm and Pulse Output

**EMC Directive 89/336/EEC:** EN 50081, EN 50082 and EN 61326-1

##### Hazardous Location Classification

Enclosure: Type 4X/ IP65

Ambient Temperature:  $-22^{\circ}\text{F} \geq T_{\text{amb}} \leq 150^{\circ}\text{F}$  ( $-30^{\circ}\text{C} \geq T_{\text{amb}} \leq 65^{\circ}\text{C}$ )

##### Intrinsically Safe

United States and Canada UL Listed, E73889

Class I, II and III, Division 1, Groups A, B, C, D, E, F, and G; T4

Europe – KEMA 01ATEX1235 X



II 2 G EEx ia IIC T4  
II 2 D T135°C

Entity Parameters (Transmitter):

$U_i = V_{\text{max}} = 30 \text{ Vdc}$ ;  $I_i = I_{\text{max}} = 140 \text{ mA}$ ;  $C_i = 15 \text{ nF}$ ;  $L_i = 0 \text{ mH}$

Entity Parameters (Integral Alarms):

$U_i = V_{\text{max}} = 30 \text{ Vdc}$ ;  $I_i = I_{\text{max}} = 45 \text{ mA}$ ;  $C_i = 0 \text{ nF}$ ;  $L_i = 0 \text{ mH}$

##### Non-Incendive

United States and Canada UL Listed, E73889, Vol. 1, Sect. 15

Class I, II, III, Division 2, Groups A, B, C, D, E, F, and G; T4

Europe – KEMA 01ATEX1236



II 3 G EEx nA II T4  
II 3 D T135° C

##### Explosion-proof/ Flame-proof

United States and Canada UL Listed, E73889, Vol. 1, Sect. 14

Class I, Division 1, Groups C, D;

Dust Ignition-proof, Class II, Division 1, Groups E, F, G

Europe – KEMA 01ATEX2207 X



II 2 G EEx d IIB T4  
II 2 D T135° C

## Data Sheet

DS-VA-MT3809-3819-eng

September, 2008

Models MT 3809 & 3819

### Power Supply and Maximum Load Resistance

21.0 to 33.5 Vdc Power Supply, refer to Figure 6 below.

Input Power: Derived from Analog Output  
(2-wire current loop transmitter)

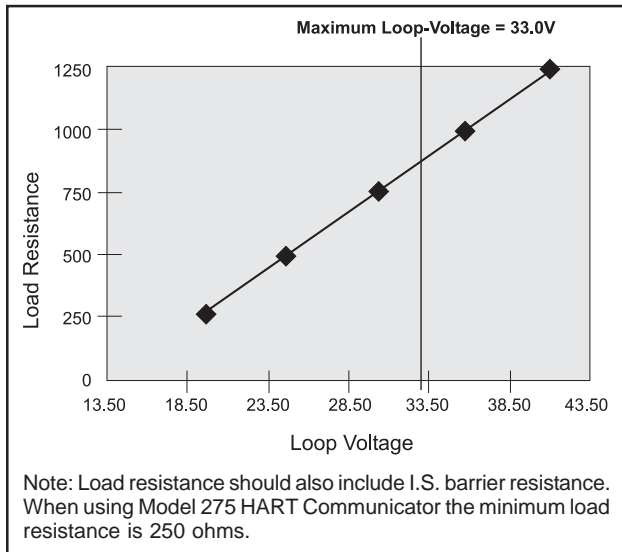

Figure 6 Power Supply vs. Maximum Load Resistance.

### Output Signals

Transmitter: 4-20 mA analog output with HART

Update Rate: 4 times per sec.

Range: 3.8 to 22.0 mA

Two Alarm Outputs (open collector)

Optically isolated outputs assignable to alarms, reverse flow indicator, or manual valve.

Maximum off-state voltage: 30 Vdc

Maximum off-state current: 0.05 mA

Maximum on-state voltage: 1.2 Vdc

Maximum on-state current: 20 mA

One Pulse Output (open collector)

Optically isolated. Scaleable to a variety of engineering unit systems (pulses per liter, gallons, etc.)

Range: 1 Hz to 1 kHz

Maximum off-state voltage: 30 Vdc

Maximum off-state current: 0.05 mA

Maximum on-state voltage: 1.2 Vdc

Maximum on-state current: 20 mA

### Linearity

Less than 1% at maximum current

### Temperature Influence

Less than 0.04% per °C

### Voltage Influence

Less than 0.002%/Vdc

### Load Resistance Influence

±0.1% full scale

### Transmitter, Alarm and Pulse Wiring Diagrams

Refer to Figures 2, 3, 4 and 5

For Division 1 explosion proof installations, the optional explosion proof enclosure must be used. This enclosure does not use the auxiliary terminal box, as shown on some of the installation diagrams. All connections are made directly within the housing. Cable entry device shall be certified as Flame-proof type, suitable per the conditions of use and correctly installed. If used with conduit, refer to Figure 7, a sealing device shall be provided in accordance with Figure 7.

For Division 2 non-incendive installations, either the standard enclosure or the explosion proof enclosure may be used.

For both Division 1 explosion proof and Division 2 non-incendive installations, the barriers shown in the installation drawings are unnecessary. However, NEC Class 2 circuits are required.

The circuits shall be wired separately or using a Multicore Cable Type B, in accordance with EN 60079-14. Also wiring must be done in accordance with the applicable electrical codes, ie., NEC Chapter 5, CEC Section 18 and any local codes.

### TRANSMITTER ACCESSORIES

General purpose and intrinsically safe HART compatible power supplies are available in 110V and 220V.

Models MT 3809 & 3819

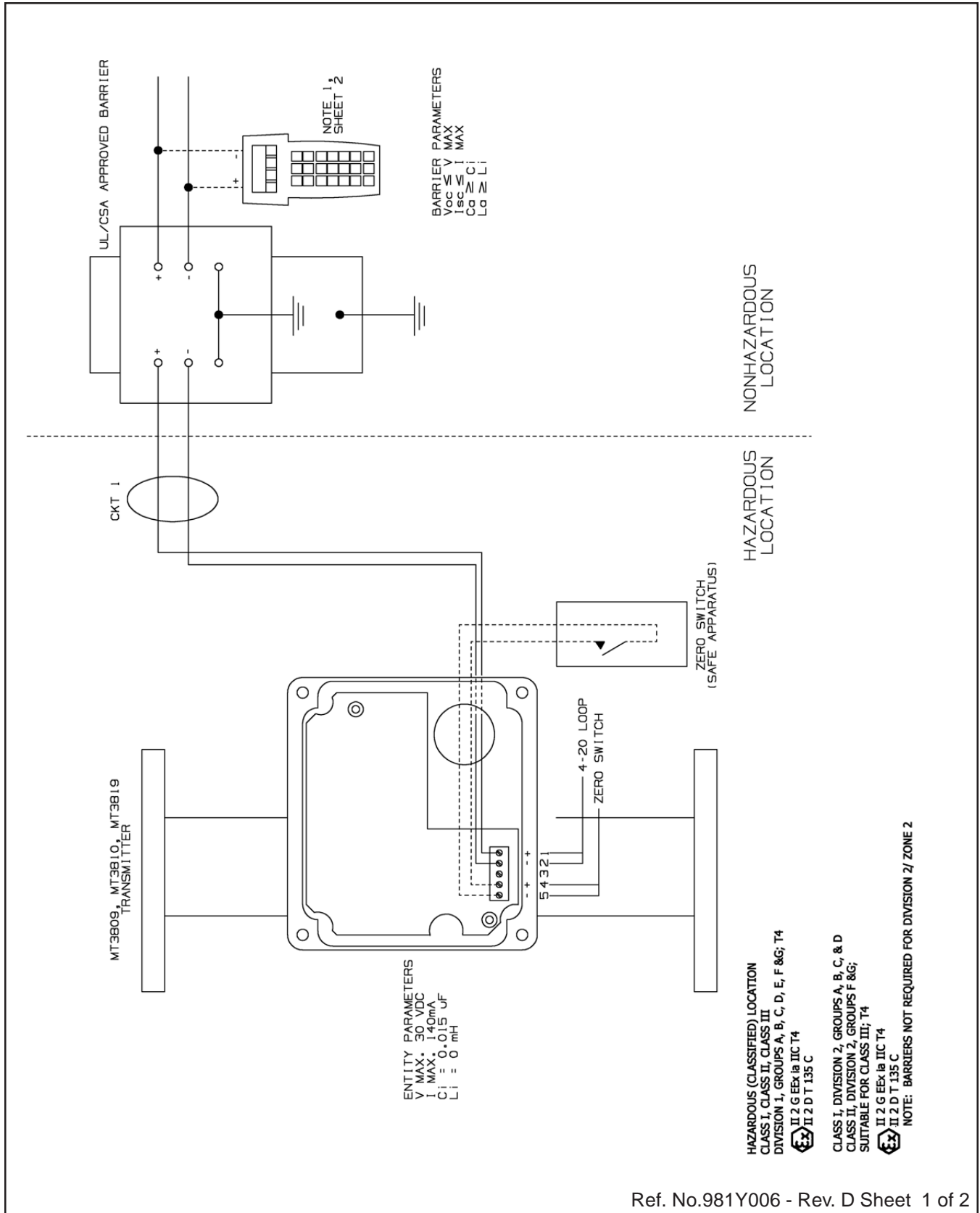

Ref. No.981Y006 - Rev. D Sheet 1 of 2

Figure 2 Transmitter Only Wiring Diagram



- NOTES:  
 1- THIS DEVICE IS A ROSEMOUNT MODEL 275 HAND HELD COMMUNICATOR.  
 2- THE LENGTH OF THE CABLES WILL BE RESTRICTED TO THE FOLLOWING VALUES:

CIRCUIT	GROUP	C (uF)	L (mH)	CABLE LENGTH
CKT1	A,B	0.14uF	2.9mH	2.333 FT MAX
CKT1	C,E	0.39uF	11.6mH	6.500 FT MAX
CKT1	D,F,G	1.04uF	23.6mH	17.333 FT MAX

- FOR INTRINSIC SAFETY PURPOSES, THE MAXIMUM CABLE LENGTH WAS CALCULATED USING A CAPACITANCE OF 60 pF/FT AND AN INDUCTANCE OF 0.20uH/FT PER UL913.
- 3- WARNING SUBSTITUTION OF COMPONENTS MAY IMPAIR INTRINSIC SAFETY.  
 AVERTISSEMENT: LA SUBSTITUTION DE COMPOSANTS PEUT COMPROMETTRE LA SECURITE INTRINSEQUE.
- 4- THE BARRIERS MUST NOT BE CONNECTED TO ANY DEVICE WHICH USES OR GENERATES IN EXCESS OF 250 VOLTS RMS OR DC UNLESS IT HAS BEEN DETERMINED THAT THE VOLTAGE HAS BEEN ADEQUATELY ISOLATED FROM THE BARRIERS.
5. REFER TO INSTRUMENT SOCIETY OF AMERICA (ISA) RECOMMENDED PRACTICE RP12.6 FOR INSTALLING INTRINSICALLY SAFE LOOPS AND THE NATIONAL ELECTRICAL CODE, NFPA 70, ARTICLE 504. FOR CANADA, INSTALLATIONS MUST BE IN ACCORDANCE WITH THE CANADIAN ELECTRICAL CODE, PART 1.

Figure 3 Transmitter Only Wiring Notes

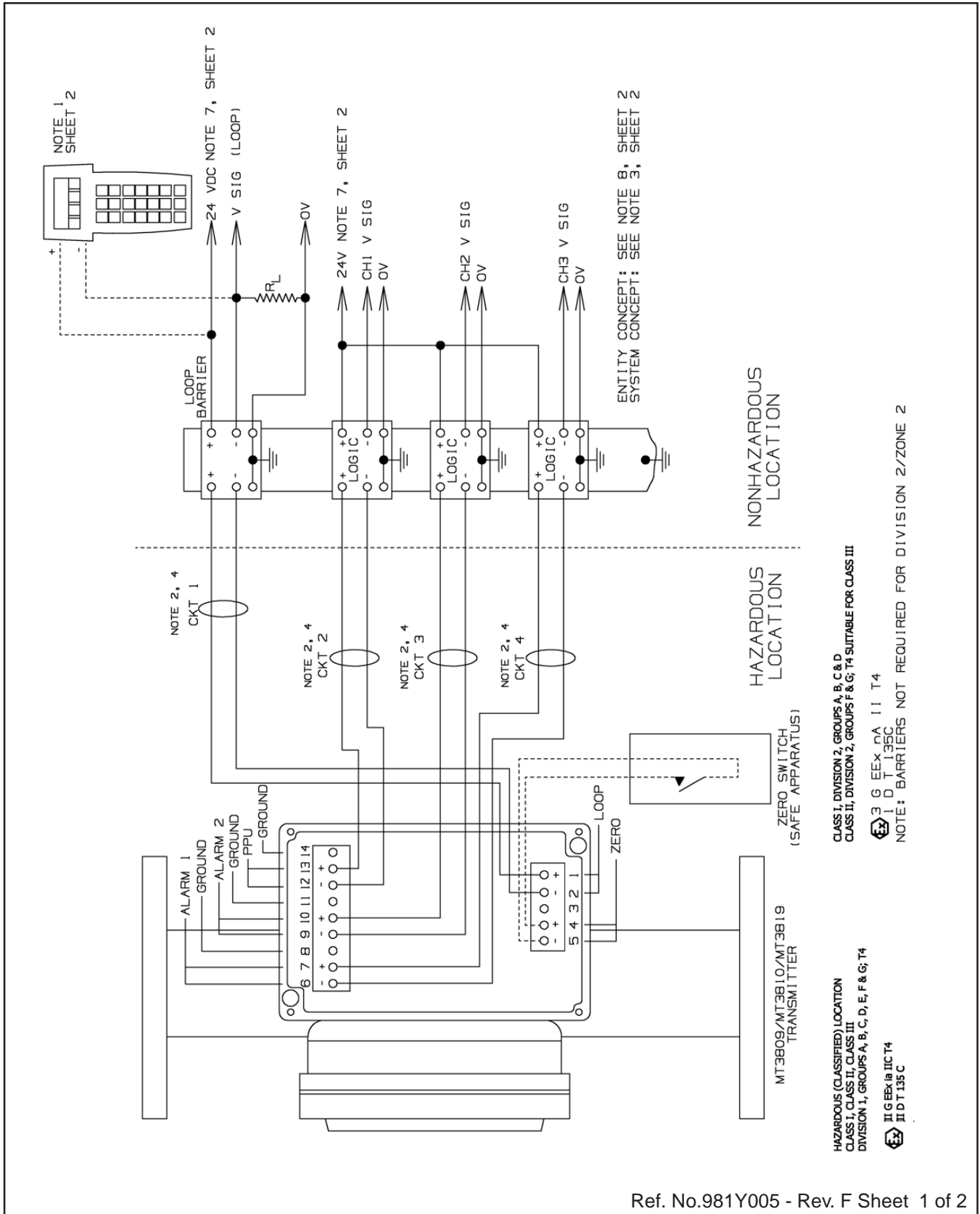

Ref. No.981Y005 - Rev. F Sheet 1 of 2

Figure 4 Transmitter with Alarm and Pulse Outputs Wiring Diagram

- NOTES:
- 1- THIS DEVICE IS A ROSEMOUNT MODEL 275 HAND HELD COMMUNICATOR.
  - 2- CKT1, CKT2, CKT3, CKT4 MUST RUN IN SEPARATE CABLES OR IN ONE CABLE WHICH HAS SUITABLE INSULATION. REFER TO INSTRUMENT SOCIETY OF AMERICA (ISA) RECOMMENDED PRACTICE RP12.6 FOR INSTALLING INTRINSICALLY SAFE LOOPS AND THE NATIONAL ELECTRICAL CODE, NFPA 70, ARTICLE 504, FOR CANADA. INSTALLATIONS MUST BE IN ACCORDANCE WITH THE CANADIAN ELECTRICAL CODE, PART 1, WHERE APPLICABLE. CKT1, CKT2, CKT3 AND CKT4 MUST BE IN COMPLIANCE WITH EN50039 CLAUSE 5.3.2; TYPE 'B' CABLE.
  - 3- LOOP BARRIER: R. STAHL INC. PART NO. 9160/13-11-11
  - 4- LOGIC BARRIER: R. STAHL INC. PART NO. 9002/77-280-094-00
  - 5- THE LENGTH OF THE CABLES WILL BE RESTRICTED TO THE FOLLOWING VALUES:

CIRCUIT	GROUP	C (uF)	L (mH)	CABLE LENGTH
CKT1	A,B	0.14uF	4.4mH	2,333 FT MAX
CKT1	C,E	0.43uF	17.2mH	7,167 FT MAX
CKT1	D,F,G	1.1uF	35.7mH	18,333 FT MAX
CKT2,3,4	A,B	0.14uF	18.5mH	2,333 FT MAX
CKT2,3,4	C,E	0.41uF	67mH	6,833 FT MAX
CKT2,3,4	D,F,G	1.1uF	155mH	18,333 FT MAX

- FOR INTRINSIC SAFETY PURPOSES, THE MAXIMUM CABLE LENGTH WAS CALCULATED USING A CAPACITANCE OF 60 pF/FT AND AN INDUCTANCE OF 0.20uH/FT PER UL913.
- 5- WARNING: SUBSTITUTION OF COMPONENTS MAY IMPAIR INTRINSIC SAFETY.
  - 6- AVERTISSEMENT: LA SUBSTITUTION DE COMPOSANTS PEUT COMPROMETTRE LA SECURITE INTRINSEQUE.
  - 7- DC UNLESS IT HAS BEEN DETERMINED THAT THE VOLTAGE HAS BEEN ADEQUATELY ISOLATED FROM THE BARRIERS.
  - 7- LOOP SUPPLY VOLTAGE: 24 VDC ±10%, LOGIC SUPPLY VOLTAGE: 24 VDC ±10%.

8- CERTIFIED ASSOCIATED APPARATUS WITH APPLICABLE DIVISION AND GROUP OR ZONE AND GROUP APPROVAL WITH ENTITY PARAMETERS:

DIVISIONS	ZONES	Alarm and Pulse Parameters
$V_{oc} \leq V_{max}$	$U_o \leq U_i$	$V_{max} = U_i = 30$
$I_{sc} \leq I_{max}$	$I_o \leq I_i$	$I_{max} = I_i = 45$
$C_a \geq C_i + C_{cable}$	$C_o \geq C_i + C_{cable}$	$C_i = 0$
$L_a \geq L_i + L_{cable}$	$L_o \geq L_i + L_{cable}$	$L_i = 0$
		Transmitter Parameters
		$V_{max} = U_i = 30$
		$I_{max} = I_i = 45$
		$C_i = 0$
		$L_i = 0$

The Entity Concept allows interconnection of intrinsically safe and associated apparatus not specifically examined in combination as a system, when the approved values of  $V_{oc}$  (or  $U_o$ ) and  $I_{sc}$  (or  $I_o$ ) for the associated apparatus are less than or equal to  $V_{max}$  (or  $U_i$ ) and  $I_{max}$  (or  $I_i$ ) for the intrinsically safe apparatus, and the values of  $C_a$  ( $C_o$ ) and  $L_a$  ( $L_o$ ) for the associated apparatus are greater than  $C_i + C_{cable}$ ,  $L_i + L_{cable}$ .

Figure 5 Transmitter with Alarm and Pulse Outputs Wiring Notes

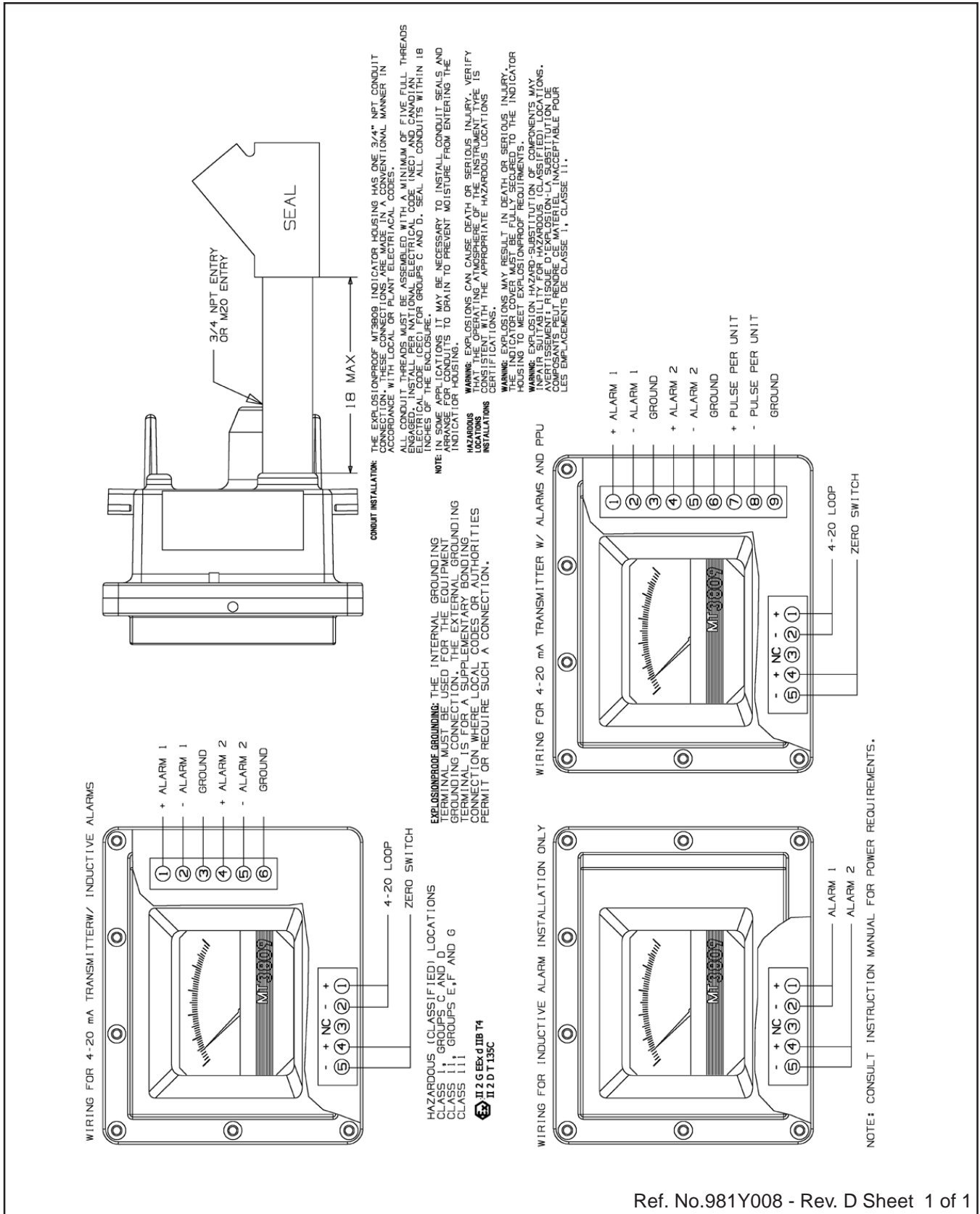
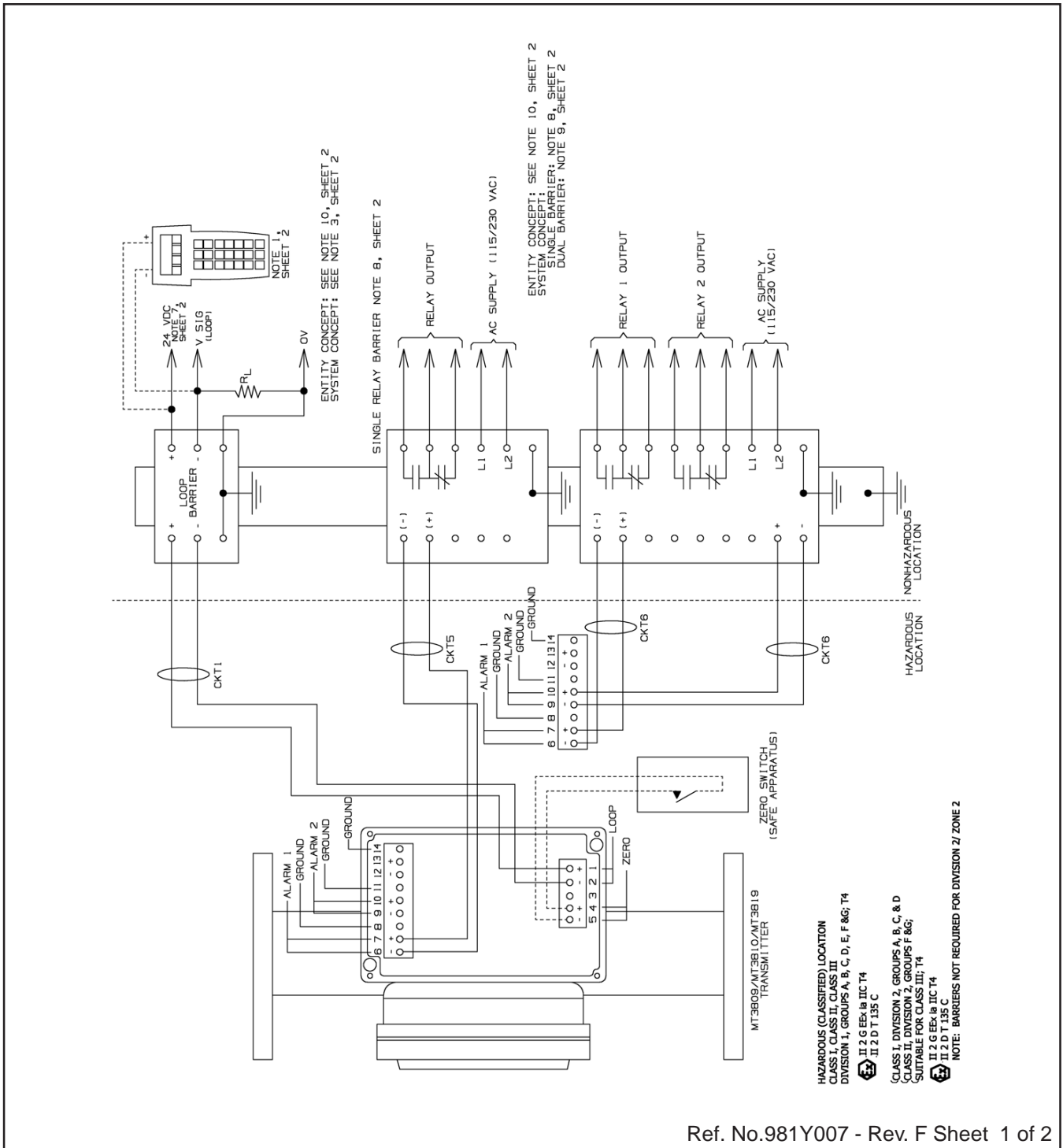

Figure 7 Model MT3809 Explosion-Proof Housing Wiring Diagram

### Optional Electronic Equipment Microprocessor Transmitter with Inductive Alarms

This combined system provides both the sophistication of the microprocessor along with the simplicity of one or two switch inductive alarms. Specifications for the transmitter are as stated previously and specifications for the front adjustable inductive alarms are as follows. For Wiring Diagrams, Refer to Figures 8 and 9.



Ref. No.981Y007 - Rev. F Sheet 1 of 2

Figure 8 Transmitter with Inductive Alarm Wiring Diagram

- NOTES:  
 1- THIS DEVICE IS A ROSEMOUNT MODEL 275 HAND HELD COMMUNICATOR.  
 2- CKT1, CKT5, AND CKT6 MUST RUN IN SEPARATE CABLES OR IN ONE CABLE WHICH HAS SUITABLE INSULATION. REFER TO INSTRUMENT SOCIETY OF AMERICA (ISA) RECOMMENDED PRACTICE RP12.6 FOR INSTALLING INTRINSICALLY SAFE LOOPS AND THE NATIONAL ELECTRICAL CODE, NFPA 70, ARTICLE 504. FOR CANADA, INSTALLATIONS MUST BE IN ACCORDANCE WITH THE CANADIAN ELECTRICAL CODE, PART 1. WHERE APPLICABLE, CKT1, CKT5, AND CKT6 MUST BE IN COMPLIANCE WITH EN50039  
 3- LOOP BARRIER: R. STAHL INC. PART NO. 9160/13-11-11  
 4- THE LENGTH OF THE CABLES WILL BE RESTRICTED TO THE FOLLOWING VALUES:

CIRCUIT	GROUP	C (uF)	L (mH)	CABLE LENGTH	BARRIER NO.
CKT1	A,B	0.14uF	4.4mH	2.333 FT MAX	9002/13-280-093-00
CKT1	C,E	0.43uF	17.2mH	7.167 FT MAX	9002/13-280-093-00
CKT1	D,F,G	1.1uF	35.7mH	18.333 FT MAX	9002/13-280-093-00
CKT5,6	A,B	1.27uF	8.48mH	21.167 FT MAX	KFD2-SR-EX2-W
CKT5,6	C,E	3.82uF	2.99mH	63.667 FT MAX	KFD2-SR-EX2-W
CKT5,6	D,F,G	1.02uF	7.44mH	169.667 FT MAX	KFD2-SR-EX2-W
CKT5,6	A,B	1.26uF	8.48mH	21.167 FT MAX	KFA5/KFA6-SR2-EX2-W
CKT5,6	C,E	3.82uF	2.99mH	63.667 FT MAX	KFA5/KFA6-SR2-EX2-W
CKT5,6	D,F,G	1.02uF	7.44mH	169.667 FT MAX	KFA5/KFA6-SR2-EX2-W
CKT5,6	A,B	6.90uF	3.40mH	10.000 FT MAX	WE77/EX1-2U
CKT5,6	C,E	2.50uF	1.30mH	41.667 FT MAX	WE77/EX1-2U
CKT5,6	D,F,G	7.50uF	3.40mH	125.000 FT MAX	WE77/EX1-2U

- FOR INTRINSIC SAFETY PURPOSES, THE MAXIMUM CABLE LENGTH WAS CALCULATED USING A CAPACITANCE OF 60 pF/FT FOR AN INDUCTANCE OF 0.20uH PER US13.0 COMPONENTS MAINTAIN INTRINSIC SAFETY.  
 5- WARNING: SUBSTITUTION OF COMPONENTS MAY IMPAIR INTRINSIC SAFETY.  
 6- THE BARRIERS MUST NOT BE CONNECTED TO ANY DEVICE WHICH USES OR GENERATES IN EXCESS OF 250 VOLTS RMS OR DC UNLESS IT HAS BEEN DETERMINED THAT THE VOLTAGE HAS BEEN ADEQUATELY ISOLATED FROM THE BARRIERS.  
 7- LOOP SUPPLY VOLTAGE: 24 VDC  $\pm$ 10%, LOGIC SUPPLY VOLTAGE: 24 VDC  $\pm$ 10%.

- 8- SINGLE RELAY BARRIER:  
 PEPPERL & FUCHS (WE77/EX1) -115 VAC, 45-60 HZ  
 (WE77/EX1-220) -230 VAC, 45-60 HZ  
 (KFA5-SR2-EX1.W 115 VAC, 45-65 HZ)  
 (KFA6-SR2-EX1.W 230 V, 45-65 HZ)  
 9- DUAL RELAY BARRIER:  
 PEPPERL & FUCHS (WE77/EX2) -115 VAC, 45-60 HZ  
 (WE77/EX2-220) -230 VAC, 45-60 HZ  
 (KFA5-SR2-EX2.W 115 VAC, 45-65 HZ)  
 (KFA6-SR2-EX2.W 230 V, 45-65 HZ)  
 DC POWERED BARRIER:  
 MTL 4016 - 20-35 VDC  
 4018 - 20-35 VDC  
 REED RELAY CONTACT RATINGS  
 IO WATTS, O.E. A, 35 VDC  
 RESPONSE TIME 2MSEC MAX  
 NOTE: REACTIVE LOADS MUST BE ADEQUATELY SUPPRESSED.  
 PEPPERL & FUCHS  
 KFD2-SR2-EX2.W  
 POWER SUPPLY 20-30 VDC, 50 MA MAX  
 Vac=8V, Isc=8 MA  
 SWITCH POINT/SWITCHING HYSTERESIS 1.2 MA-2.1 MA/ $\approx$ 0.2 MA  
 INPUT PULSE LENGTH/INPUT PULSE PAUSE  $\approx$  20 MSEC/ $\approx$  20 MSEC  
 OUTPUT: AC 250V/2A/Cos $\phi$ >0.7  
 DC 40V/2A RESISTIVE  
 RESPONSE TIME  $\approx$  20 MSEC

RELAY RATINGS (PEPPERL & FUCHS WE77/EX1)  
 AC V MAX  $\approx$  250 VAC  
 I MAX  $\approx$  2 AMP  
 P MAX  $\approx$  500 VA/Cos 0=0.7  
 DC 110 VDC/0.2 AMP  
 60 VDC/0.6 AMP  
 24 VDC/4.0 AMP

RELAY RATINGS (PEPPERL & FUCHS WE77/EX2)  
 AC V MAX  $\approx$  250 VAC  
 I MAX  $\approx$  4 AMP  
 P MAX  $\approx$  500 VA/Cos 0=0.7  
 DC 110 VDC/0.2 AMP  
 60 VDC/0.6 AMP  
 24 VDC/4.0 AMP

RELAY RATINGS (PEPPERL & FUCHS KFA5/KFA6)  
 AC V MAX  $\approx$  250 VAC  
 I MAX  $\approx$  2 AMP  
 P MAX  $\approx$  530VA/Cos $\phi$ >0.7  
 DC 40V/2A RESISTIVE LOAD

- 10- Certified associated apparatus with applicable division and group or zone and group approval with entity parameters:

DIVISIONS	PARAMETERS	ALARM and PULSE Parameters
$V_{oc} \approx V_{max}$	$I_{oc} \approx I_{i}$	$V_{max} U_i = 16$
$C_a \geq C_i + C_{cable}$	$L_a \geq L_i + L_{cable}$	$I_{max} I_i = 25 \text{ mA}$
$L_a \geq L_i + L_{cable}$	$L_i \geq 0$	$C_i = 50 \text{ nF}$
		$L_i = 250 \text{ uH}$

The Entity Concept allows interconnection of intrinsically safe and associated apparatus not specifically examined in combination as a system, when the approved values of  $V_{oc}$  (or  $V_{o}$ ) and  $I_{sc}$  (or  $I_{o}$ ) for the associated apparatus are less than or equal to  $V_{max}$  (or  $V_{i}$ ) and  $I_{max}$  (or  $I_i$ ) for the intrinsically safe apparatus, and the values of  $C_a$  ( $C_o$ ) and  $L_a$  ( $L_o$ ) for the associated apparatus are greater than  $C_i$  +  $C_{cable}$ ,  $L_i$  +  $L_{cable}$ .

Figure 9 Transmitter with Inductive Alarm Wiring Notes

## Inductive Alarm Switches

### Design

- 1 or 2 normally open inductive limit switches
- Optional intrinsically safe power supply/amplifier/relay unit
- For low or high limit signaling/switching
- Front adjustable

### Description

One or 2 electronic limit switches can be installed in the indicator housing to allow initiation of signaling or switching functions on a preset flow value. The limit switch operates as a slot initiator that is inductively actuated by a disc mounted on the pointer shaft. Any flow value can be used for setting the limit value by sliding the initiator along the indicator scale. Minimum setting distance between two limit switches is approximately 40% full scale. The position of the initiator also serves to visually indicate the set value. Settings can be adjusted by removing the indicator cover, loosening, moving and retightening of the alarm indication needle, and replacement of the indicator cover.

### Specifications

**EMC Directive 89/336/EEC:** EN 50081, EN 50082 and EN 61326-1

#### Hazardous Location Classification

Enclosure: Type 4X/ IP65

Ambient Temperature:  $-22^{\circ}\text{F} \geq T_{\text{amb}} \leq 150^{\circ}\text{F}$  ( $-30^{\circ}\text{C} \geq T_{\text{amb}} \leq 65^{\circ}\text{C}$ )

#### Intrinsically Safe

United States and Canada UL Listed, E73889  
Class I, II and III, Division 1, Groups A, B, C, D, E, F, and G;  
T4

Europe – KEMA 01ATEX1235 X



II 2 G EEx ia IIC T4  
II 2 D T135°C

#### Entity Parameters:

$U_i = V_{\text{max}} = 16 \text{ Vdc}$ ;  $I_i = I_{\text{max}} = 25 \text{ mA}$ ;  $C_i = 50 \text{ uF}$ ;

$L_i = 250 \text{ uF}$

#### Non-Incendive

United States and Canada UL Listed, E73889  
Class I, II, III, Division 2, Groups A, B, C, D, F, and G; T4

Europe – KEMA 01ATEX1236



II 3 G EEx nA II T4  
II 3 D T135°C

#### Explosion-proof/ Flame-proof

United States and Canada UL Listed, E73889

Class I, Division 1, Groups C, D;

Dust Ignition-proof, Class II, Division 1, Groups E, F, G; Class III; T4

Europe – KEMA 01ATEX2207 X



II 2 G EEx d IIB T4  
II 2 D T135°C

#### Power Supply

5-25 Vdc; 25 mA max.

#### Impedance

Approximately 1 kohm with cam absent

Approximately 8 kohm with cam present

#### Maximum Operating Temperature

Refer to Table 3

#### Alarm Wiring Diagrams

Explosion-proof/ Flame-proof: Refer to Figure 7

Intrinsically Safe or Non Incendive: Refer to Figures 8 and 9

For Division 1 explosion proof installations, the optional explosion proof enclosure must be used. This enclosure does not use the auxiliary terminal box, as shown on some of the installation diagrams. All connections are made directly within the housing. Cable entry device shall be certified as Flame-proof type, suitable per the conditions of use and correctly installed. If used with conduit, refer to Figure 7, a sealing device shall be provided in accordance with Figure 7.

For Division 2 non-incendive installations, either the standard enclosure or the explosion proof enclosure may be used.

For both Division 1 explosion proof and Division 2 non-incendive installations, the barriers shown in the installation drawings are unnecessary. However, NEC Class 2 circuits are required.

The circuits shall be wired separately or using a Multicore Cable Type B, in accordance with EN 60079-14. Also wiring must be done in accordance with the applicable electrical codes, ie., NEC Chapter 5, CEC Section 18 and any local codes.

#### Alarm Accessories

Amplifier Power Supply (approved isolated barrier) 1 or 2 channel approved for intrinsically safe application, remotely mounted, 115 or 230 Vac power. Single pole with double throw (SPDT) relay standard. For other configurations, consult factory.

Models MT 3809 & 3819

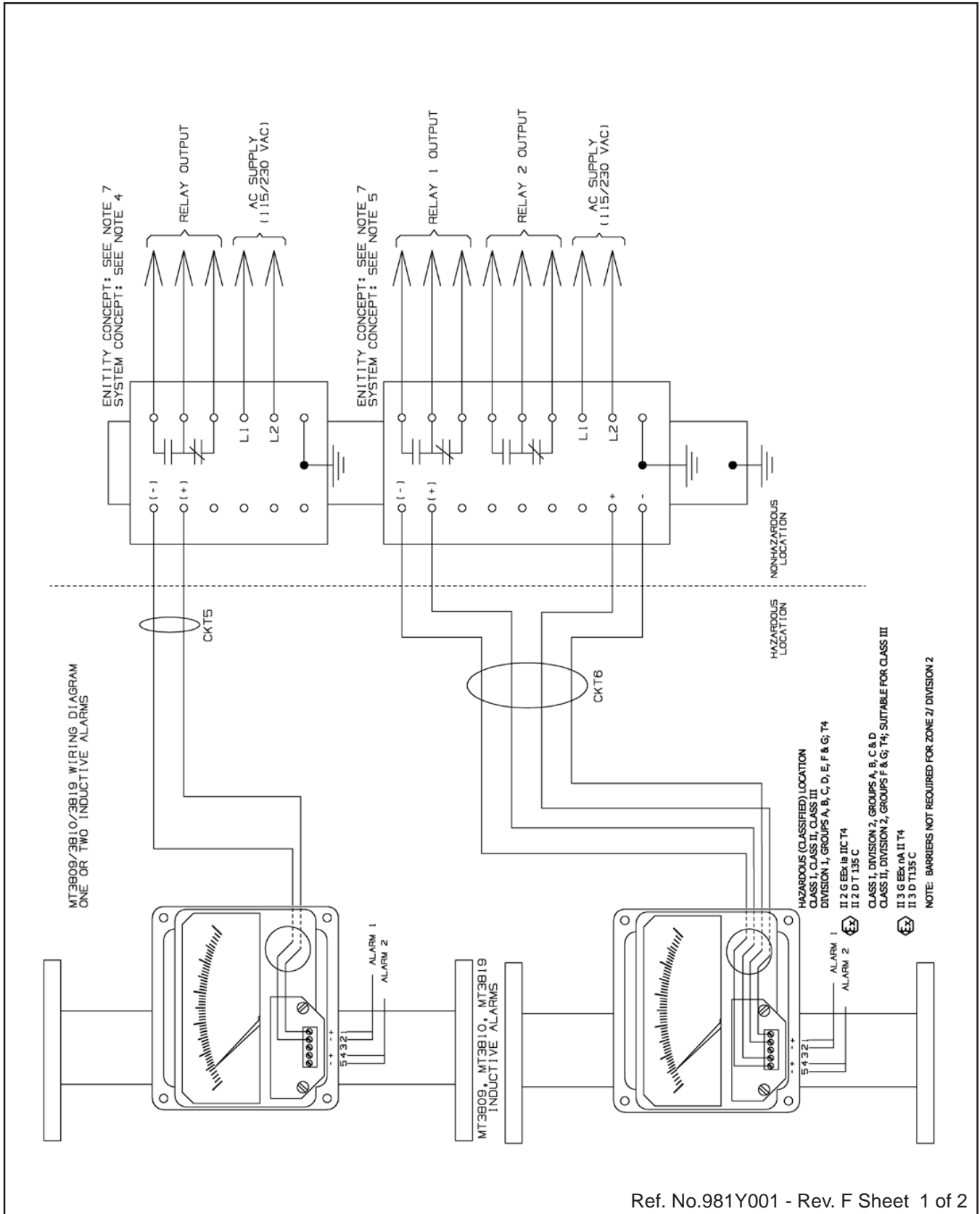

Ref. No.981Y001 - Rev. F Sheet 1 of 2

Figure 10 Inductive Alarms Only Wiring Diagram



NOTES:  
 1- CKT5 AND CKT6 MUST RUN IN SEPARATE CABLES OR IN ONE CABLE WHICH HAS SUITABLE INSULATION. REFER TO INSTRUMENT SOCIETY OF AMERICA (ISA) RECOMMENDED PRACTICE RPI2.6 FOR INSTALLING INTRINSICALLY SAFE LOOPS AND THE NATIONAL ELECTRICAL CODE, NFPA 70, ARTICLE 504. FOR CANADA, INSTALLATIONS MUST BE IN ACCORDANCE WITH THE CANADIAN ELECTRICAL CODE, PART 1.

THE LENGTH OF THE CABLES WILL BE RESTRICTED TO THE FOLLOWING VALUES:

CIRCUIT	GROUP	C (uF)	L (mH)	CABLE LENGTH	BARRIER NO.
CKT5.6	A,B	3.20UF	9.48mH	211.667 FT MAX	KFD2-SR2-EX2.W
CKT5.6	C,E	3.80UF	7.99mH	193.167 FT MAX	KFD2-SR2-EX2.W
CKT5.6	D,F,G	1.26UF	9.48mH	211.667 FT MAX	KFD2-SR2-EX2.W
CKT5.6	C,E	3.80UF	7.44mH	169.667 FT MAX	KFA5/KFA6-SR2-EX2.W
CKT5.6	D,F,G	6.00UF	3.40mH	10.000 FT MAX	WE77/EX1-2U
CKT5.6	C,E	2.50UF	1.30mH	41.667 FT MAX	WE77/EX1-2U
CKT5.6	D,F,G	7.50UF	3.00mH	125.000 FT MAX	WE77/EX1-2U

FOR INTRINSIC SAFETY PURPOSES, THE MAXIMUM CABLE LENGTH WAS CALCULATED USING A CAPACITANCE OF 60 pF/FT AND AN INDUCTANCE OF 1.20uH/FT PER UL913.

2- WARNING: SUBSTITUTION OF COMPONENTS MAY IMPAIR INTRINSIC SAFETY.  
 AVERTISSEMENT: LA SUBSTITUTION DE COMPOSANTS PEUT COMPROMETTRE LA SECURITE INTRINSEQUE.  
 3- THE BARRIERS MUST NOT BE CONNECTED TO ANY DEVICE WHICH USES OR GENERATES IN EXCESS OF 250 VOLTS RMS OR DC UNLESS IT HAS BEEN DETERMINED THAT THE VOLTAGE HAS BEEN ADEQUATELY ISOLATED FROM THE BARRIERS.

4- SINGLE RELAY BARRIER:  
 PEPPERL & FUCHS (WE77/EX1)-115 VAC, 45-60 HZ  
 (WE77/EX1-220)-230 VAC, 45-60 HZ  
 (KFA5-SR2-EX1.W 115 VAC, 45-65 HZ)  
 (KFA6-SR2-EX1.W 230 V, 45-65 HZ)

5- DUAL RELAY BARRIER:  
 PEPPERL & FUCHS (WE77/EX2)-115 VAC, 45-60 HZ  
 (WE77/EX2-220)-230 VAC, 45-60 HZ  
 (KFA5-SR2-EX2.W 115 VAC, 45-65 HZ)  
 (KFA6-SR2-EX2.W 230 V, 45-65 HZ)

DC POWERED BARRIER  
 MTL 4016 - 20-35 VDC  
 45-60 mA  
 REED RELAY CONTACT RATINGS  
 10 WATTS, 0.5 A, 35 VDC  
 RESPONSE TIME 2MSEC MAX  
 NOTE: REACTIVE LOADS MUST BE ADEQUATELY SUPPRESSED.

PEPPERL & FUCHS  
 KFD2-SR2-EX2.W  
 POWER SUPPLY 20-30 VDC, 50 MA MAX  
 Voc=8V, Isc=8 MA  
 SWITCH POINT/SWITCHING HYSTERESIS 1.2 MA-2.1 MA/≈0.2 MA  
 INPUT PULSE LENGTH/INPUT PULSE PAUSE ≥20 MSEC/≥20 MSEC  
 OUTPUT: AC 250V/2A/Cosφ >0.7  
 DC 40V/2A RESISTIVE  
 RESPONSE TIME ≈20 MSEC

RELAY RATINGS (PEPPERL & FUCHS WE77/EX1)  
 AC V MAX ≤ 250 VAC  
 I MAX ≤ 4 AMP  
 P MAX ≤ 2 AMP  
 DC 110 VDC/0.2 AMP  
 60 VDC/0.6 AMP  
 24 VDC/4.0 AMP

RELAY RATINGS (PEPPERL & FUCHS KFA5/KFA6)  
 AC V MAX ≤ 250 VAC  
 I MAX ≤ 2 AMP  
 P MAX ≤ 253V/2A Cosφ >0.7  
 DC 40V/2A RESISTIVE LOAD

PARAMETERS  
 Vmax=Ui-16  
 Imax=Ii=25 mA  
 Ci=50nF  
 Li=250 uH

ZONES  
 Uo ≤ Ui  
 Io ≤ Ii  
 Co ≥ Ci = Ccable  
 Lo ≥ Li = Lcable

The Entity Concept allows interconnection of intrinsically safe and associated apparatus not specifically examined in combination as a system, when the approved values of Voc (or Uo) and Isc (or Io) for the associated apparatus are less than or equal to Vmax (or Ui) and Imax (or Ii) for the intrinsically safe apparatus, and the values of Co (Ci) and Lo (Li) for the associated apparatus are greater than Ci + Ccable, Li + Lcable.

6- WHERE APPLICABLE CKT5,CKT6,MUST BE IN COMPLIANCE WITH EN50039 CLAUSE 5.3.2; TYPE B CABLE.

7- CERTIFIED ASSOCIATED APPARATUS WITH APPLICABLE DIVISION AND GROUP OR ZONE AND GROUP APPROVAL WITH ENTITY PARAMETERS:

Ref. No.981Y001 - Rev. F Sheet 2 of 2

Figure 11 Inductive Alarms Only Wiring Notes

# Models MT 3809 & 3819

Table 4 Ordering Information and Model Code

MODEL	BASIC MODEL TYPE								
3809E	THRU-FLOW METER, THREADED & FLANGED CONNECTIONS								
	CODE	MATERIALS OF CONSTRUCTION (Body, Float and Fittings/Flanges)							
	1	316/316L SS							
	A	316/316L SS Certification to EN 10204 2.2							
	B	316/316L SS Certification to EN 10204 3.1							
	3	Hastelloy C-276							
	5	Titanium							
	6	Inconel 625							
	METER AND CONNECTION SIZE								
	CODE	METER SIZE	STANDARD CONNECTION SIZE		CONNECTION SIZE NPT (M) No O-Ring Only	METER LAY LENGTH			
			FLANGED	NPT (F)		FLANGED	NPT (F)	NPT (M)	
	1	7	1/2"	1/2"	1"	250mm	225mm	200mm	
	2	8	1/2"	1/2"	1"	250mm	225mm	200mm	
	3	10	1"	1"	1.5"	250mm	300mm	250mm	
	4	12	1.5"	1.5"	2 1/2"	250mm	300mm	250mm	
	5	13	2"	2"		250mm	300mm		
	6	15	3"			250mm			
	7	16	4"			350mm			
		METER SIZE	OVERSIZED CONNECTION SIZE FLANGED ONLY				FLANGED		
	A	7	1"			NOTE:	250mm		
	B	8	1"			Oversized	250mm		
	C	10	1.5"			connections	250mm		
	D	12	2"			available in 150#,	250mm		
	E	13	3"			300# and DIN	250mm		
	F	15	4"			only	250mm		
	MAXIMUM FLOW								
		NOTE: LIQUID FLOW BASED ON WATER Sp.Gr. 1.0, Visc 1.0 CP							
		AIR FLOWS FOR SCFM ARE @ 14.7 PSIA AND 70 oF (21oC); NM3/H @ 14.7 PSIA AND 32 oF (0 oC)							
	CODE	SIZE 7	SIZE 8	SIZE 10	SIZE 12	SIZE 13	SIZE 15	SIZE 16	
	A	0.11 GPM	1.10 GPM	5.28 GPM	17.60 GPM	28.6 GPM	88 GPM	220 GPM	
	A	25 L/H	250 L/H	1200 L/H	4000 L/H	6500 L/H	20000 L/H	50000 L/H	
	A	0.49 SCFM	5.25 SCFM	19.35 SCFM	67.02 SCFM	102 SCFM	392 SCFM	NA	
	A	0.78 NM3/H	8.30 NM3/H	30.60 NM3/H	106 NM3/H	162 NM3/H	620 NM3/H	NA	
	B	0.29 GPM	1.76 GPM	6.60 GPM	26.40 GPM	41.8 GPM	132 GPM	308 GPM	
	B	65 L/H	400 L/H	1500 L/H	6000 L/H	9500 L/H	30000 L/H	70000 L/H	
	B	1.30 SCFM	7.71 SCFM	25.61 SCFM	95 SCFM	161 SCFM	550 SCFM	NA	
	B	2.05 NM3/H	12.20 NM3/H	40.50 NM3/H	150 NM3/H	255 NM3/H	935 NM3/H	NA	
	C	0.59 GPM	2.86 GPM	10.56 GPM	35.2 GPM	55.00 GPM	176 GPM	440 GPM	
	C	135 L/H	650 L/H	2400 L/H	8000 L/H	12500 L/H	40000 L/H	100000 L/H	
	C	2.40 SCFM	11.76 SCFM	41.73 SCFM	151 SCFM	202 SCFM	750 SCFM	NA	
	C	3.80 NM3/H	18.60 NM3/H	66.00 NM3/H	239 NM3/H	319 NM3/H	1275 NM3/H	NA	
	D	0.88 GPM	4.40 GPM	15.40 GPM	46.2 GPM	88 GPM			
	D	200 L/H	1000 L/H	3500 L/H	10500 L/H	20000 L/H			
	D	3.73 SCFM	21.37 SCFM	65.44 SCFM	212 SCFM	392 SCFM			
	D	6.34 NM3/H	33.80 NM3/H	103.5 NM3/H	335 NM3/H	620 NM3/H			
	CODE	CONNECTION TYPE							
	1	NPT (F) with Viton O'Ring (Sizes 7-13 only; up to 350 oF (177 oC))							
	2	NPT (F) with Teflon O'Ring (Sizes 7-13 only; up to 450 oF (232 oC))							
	3	NPT (M) - No O'Ring (Sizes 7-13 only; up to 617 oF(325 oC))							
	4	JIS B 0203 Threaded with Viton O'Ring (Sizes 7-13 only; up to 350 oF (177 oC))							
	5	JIS B 0203 Threaded with Teflon O'Ring (Sizes 7-13 only; up to 450 oF (232 oC))							
	6	JIS B 0203 Threaded; No O'Ring (Sizes 7-13 only; up to 617 oF(325 oC))							
	A	ANSI 150# RF							
	B	ANSI 300# RF							
	C	ANSI 600# RF							
	D	DIN PN40							
	E	JIS 10K RF							
	F	JIS 20K RF							

3809E

1

1

C

1

Table 4 Ordering Information and Model Code (Continued)

METER ACCURACY/SCALE INSCRIPTION/FLUID			
CODE	METER ACCURACY	SCALE INSCRIPTION	FLUID
G	2% FULL SCALE	% SCALE	LIQUID
H	2% FULL SCALE	DIRECT	LIQUID
J	2% FULL SCALE	% SCALE	GAS
K	2% FULL SCALE	DIRECT	GAS
L	2% FULL SCALE	% SCALE	LIQUID HIGH VISCOSITY (SEE CAPACITY TABLE FOR LIMITS)
M	2% FULL SCALE	DIRECT	LIQUID HIGH VISCOSITY (SEE CAPACITY TABLE FOR LIMITS)
A	1% FULL SCALE	% SCALE	LIQUID
B	1% FULL SCALE	DIRECT	LIQUID
C	1% FULL SCALE	% SCALE	GAS
D	1% FULL SCALE	DIRECT	GAS
4	2% FULL SCALE	Dual Scales % and/or Direct*	LIQUID
5	2% FULL SCALE	Dual Scales % and/or Direct*	GAS
6	2% FULL SCALE	Dual Scales % and/or Direct*	LIQUID HIGH VISCOSITY (SEE CAPACITY TABLE FOR LIMITS)
1	1% FULL SCALE	Dual Scales % and/or Direct*	LIQUID
2	1% FULL SCALE	Dual Scales % and/or Direct*	GAS

\*Dual inscription scales are not available with any 4-20 mA transmitter or alarm options

INDICATION CONFIGURATION				
CODE	HOUSING	MATERIAL	FINISH	INDICATOR FUNCTION
A	Standard	Aluminum	Polyurethane	Indicator only
B	Standard	Aluminum	Polyurethane	Inductive Alarm only, 1 Switch
C	Standard	Aluminum	Polyurethane	Inductive Alarm only, 2 Switches
D	Standard	Aluminum	Polyurethane	4-20 mA uP Transmitter only
E	Standard	Aluminum	Polyurethane	4-20mA uP Xmtr & Inductive Alarm 1 Sw
F	Standard	Aluminum	Polyurethane	4-20mA uP Xmtr & Inductive Alarm 2 Sw
G	Standard	Aluminum	Polyurethane	4-20mA uP Xmtr w/Pulse Output & Alarm Contacts
H	Standard	Aluminum	Epoxy	Indicator only
J	Standard	Aluminum	Epoxy	Inductive Alarm only, 1 Switch
K	Standard	Aluminum	Epoxy	Inductive Alarm only, 2 Switch
L	Standard	Aluminum	Epoxy	4-20 mA uP Transmitter only
M	Standard	Aluminum	Epoxy	4-20mA uP Xmtr & Inductive Alarm 1 Sw
N	Standard	Aluminum	Epoxy	4-20mA uP Xmtr & Inductive Alarm 2 Sw
P	Standard	Aluminum	Epoxy	4-20mA uP Xmtr w/Pulse Output & Alarm Contacts
Q	Corrosion Resistant	Stn. Stl.	Grit Blast	Indicator only
R	Corrosion Resistant	Stn. Stl.	Grit Blast	Inductive Alarm only, 1 Switch
S	Corrosion Resistant	Stn. Stl.	Grit Blast	Inductive Alarm only, 2 Switch
T	Corrosion Resistant	Stn. Stl.	Grit Blast	4-20 mA uP Transmitter only
U	Corrosion Resistant	Stn. Stl.	Grit Blast	4-20mA uP Xmtr & Inductive Alarm 1 Sw
V	Corrosion Resistant	Stn. Stl.	Grit Blast	4-20mA uP Xmtr & Inductive Alarm 2 Sw
W	Corrosion Resistant	Stn. Stl.	Grit Blast	4-20mA uP Xmtr w/Pulse Output & Alarm Contacts
1	Ex. Proof	Aluminum	Epoxy	Inductive Alarm only, 1 Switch
2	Ex. Proof	Aluminum	Epoxy	Inductive Alarm only, 2 Switch
3	Ex. Proof	Aluminum	Epoxy	4-20 mA uP Transmitter only
4	Ex. Proof	Aluminum	Epoxy	4-20mA uP Xmtr & Inductive Alarm 1 Sw
5	Ex. Proof	Aluminum	Epoxy	4-20mA uP Xmtr & Inductive Alarm 2 Sw
6	Ex. Proof	Aluminum	Epoxy	4-20mA uP Xmtr W/Pulse Output & Alarm Contacts

3809E11C1

G A

Models MT 3809 & 3819

Table 4 Ordering Information and Model Code (Continued)

CODE	RELAY/POWER SUPPLY OPTIONS	
A	None	
B	Power Supply Relay Unit - 220VAC - 1 Channel (For use with inductive alarms only)	
C	Power Supply Relay Unit - 220VAC - 2 Channel (For use with inductive alarms only)	
D	Power Supply Relay Unit - 110VAC - 1 Channel (For use with inductive alarms only)	
E	Power Supply Relay Unit - 110VAC - 2 Channel (For use with inductive alarms only)	
F	General Purpose Power Supply, 24 VDC (For use with 4-20mA transmitter only)	
G	General Purpose Power Supply, 110VAC Input (For use with 4-20mA transmitter only)	
H	General Purpose Power Supply, 220VAC Input (For use with 4-20mA transmitter only)	
J	Intrinsically Safe Power Supply, 24Vdc Input (For use with 4-20mA transmitter only)	
K	Intrinsically Safe Power Supply, 110Vdc Input (For use with 4-20mA transmitter only)	
L	Intrinsically Safe Power Supply, 220Vdc Input (For use with 4-20mA transmitter only)	
CODE	CERTIFICATIONS	
1	None	
A	Certificate for NIST Traceability	
B	Certificate acc. N.A.C.E. MR-01-75	
G	Certificate for NIST Traceability & N.A.C.E. MR-01-75	
CODE	ACCESSORIES (NOTE 3 & 4)	METER LIMITATIONS
A	None	
B	High Temperature Design	> 420oF (215oC) std. indicator > 195oF (90oC) with transmitter options > 320oF (160oC) with inductive alarms only
C	Low Ambient Temperature to -58F/-50C	Standard Aluminum Housing only
D	8802 Flow controller mounting hardware	Size 7, float codes A & B only
E	8805 Flowcontroller mounting hardware	Size 7, float codes A & B only
F	8902 Flowcontroller mounting hardware	Size 7, float codes A & B only
H	8810 Flowcontroller mounting hardware	Size 7, float codes C & D; Size 8, float codes A & B only
J	8815 Flowcontroller mounting hardware	Size 7, float codes C & D; Size 8, float codes A & B only
K	8910 Flowcontroller mounting hardware	Size 7, float codes C & D; Size 8, float codes A & B only
M	8830 Flowcontroller mounting hardware	Size 8, float codes C & D; Size 10, float codes A & B only
N	1/4" Valve on Inlet (1/4" in/1/2" out) Cv=0.3	Size 7, float codes A, B, & C only
P	1/4" Valve on Outlet (1/2" in/1/4" out) Cv=0.3	Size 7, float codes A, B, & C only
Q	1/2" Valve on Inlet Cv=1.16	Size 7, float code D; Size 8, float codes A, B & C only
R	1/2" Valve on Outlet Cv=1.16	Size 7, float code D; Size 8, float codes A, B & C only
S	1" Valve on Inlet Cv=3.93	Size 8, float code D; Size 10, all float codes
T	1" Valve on Outlet Cv=3.93	Size 8, float code D; Size 10, all float codes
W	1 - 1/2" Valve on Inlet Cv=12.14	Size 12, all float codes
X	1 - 1/2" Valve on Outlet Cv=12.14	Size 12, all float codes
CODE	SOFTWARE REVISION LEVEL (for uP Transmitter)	
1	Not Applicable - uP Transmitter not part of meter	
A	Initial Release	

NOTE 3: FLOW CONTROLLER UNITS MUST BE ORDERED AS SEPARATE LINE ITEMS  
NOTE 4: FLOW CONTROLLERS AND VALVES AVAILABLE WITH NPT CONNECTIONS ONLY.

3809E11C1GA      A      1      A      1

**Data Sheet**

DS-VA-MT3809-3819-eng

September, 2008

Models MT 3809 &amp; 3819

Table 4 Ordering Information and Model Code (Continued)

APPROXIMATE SHIPPING WEIGHT LBS (KG):	METER SIZE					
	7-8	10	12	13	15	16
WEIGHT 150# R.F. flange w/ indicator only LBS (KG)	6 (2.7)	10 (4.5)	15 (6.8)	20 (9)	33 (15)	64 (29)
WEIGHT 150# R. F. flange w/transmitter LBS (KG)	7 (3.1)	11 (5)	16 (7.2)	21 (9.5)	34 (15.4)	65 (29.5)
WEIGHT 150# R. F. flange w/inductive alarms LBS (KG)	7 (3.1)	11 (5)	16 (7.2)	21 (9.5)	34 (15.4)	65 (29.5)
WEIGHT NPT (F) w/ indicator only LBS (KG)	3 (1.3)	7 (3.1)	12 (5.4)	14 (6.3)	NA	NA
WEIGHT NPT (F) flange w/transmitter LBS (KG)	4 (1.8)	8 (3.6)	13 (5.9)	15 (6.8)	NA	NA
WEIGHT NPT (F) flange w/inductive alarms LBS (KG)	4 (1.8)	8 (3.6)	13 (5.9)	15 (6.8)	NA	NA

## Models MT 3809 & 3819

---

### **BROOKS SERVICE AND SUPPORT**

Brooks is committed to assuring all of our customers receive the ideal flow solution for their application, along with outstanding service and support to back it up. We operate first class repair facilities located around the world to provide rapid response and support. Each location utilizes primary standard calibration equipment to ensure accuracy and reliability for repairs and recalibration. The primary standard calibration equipment to calibrate our flow products is certified by our local Weights and Measures Authorities and traceable to the relevant International Standards.

Visit [www.BrooksInstrument.com](http://www.BrooksInstrument.com) to locate the service location nearest to you.

### **START-UP SERVICE AND IN-SITU CALIBRATION**

Brooks Instrument can provide start-up service prior to operation when required. For some process applications, where ISO-9001 Quality Certification is important, it is mandatory to verify and/or (re)calibrate the products periodically. In many cases this service can be provided under in-situ conditions, and the results will be traceable to the relevant international quality standards.

### **CUSTOMER SEMINARS AND TRAINING**

Brooks Instrument can provide customer seminars and dedicated training to engineers, end users and maintenance persons. Please contact your nearest sales representative for more details.

### **HELP DESK**

In case you need technical assistance:

Americas ☎ 1-888-554-FLOW  
Europe ☎ +(31) 318 549 290      Within Netherlands ☎ 0318 549 290  
Asia ☎ +011-81-3-5633-7100

Due to Brooks Instrument's commitment to continuous improvement of our products, all specifications are subject to change without notice.

### **TRADEMARKS**

Brooks ..... Brooks Instrument, LLC  
Emerson ..... Emerson Electric Co.  
HART ..... HART Communications Foundation  
Hastelloy C ..... E.I. DuPont de Nemours & Co.  
Inconel ..... Inco Alloy International Inc.  
Smart Meter Manager ..... Brooks Instrument, LLC  
SMM ..... Brooks Instrument, LLC  
Teflon ..... E.I. DuPont de Nemours & Co.  
Tefzel ..... E.I. DuPont de Nemours & Co.  
Viton ..... DuPont Performance Elastomers



**Brooks Instrument**  
407 West Vine Street  
P.O. Box 903  
Hatfield, PA 19440-0903 USA  
T (215) 362-3700  
F (215) 362-3745  
E-Mail [BrooksAm@BrooksInstrument.com](mailto:BrooksAm@BrooksInstrument.com)  
[www.BrooksInstrument.com](http://www.BrooksInstrument.com)

**Brooks Instrument**  
Neonstraat 3  
6718 WX Ede, Netherlands  
T 31-318-549-300  
F 31-318-549-309  
E-Mail [BrooksEu@BrooksInstrument.com](mailto:BrooksEu@BrooksInstrument.com)

**Brooks Instrument**  
1-4-4 Kitasuna Koto-Ku  
Tokyo, 136-0073 Japan  
T 011-81-3-5633-7100  
F 011-81-3-5633-7101  
E-Mail [BrooksAs@BrooksInstrument.com](mailto:BrooksAs@BrooksInstrument.com)